



# BUILD

Construye  
Construis

Bau  
Costruite

Bouw  
Bygg

Byg

## Distribution Depot

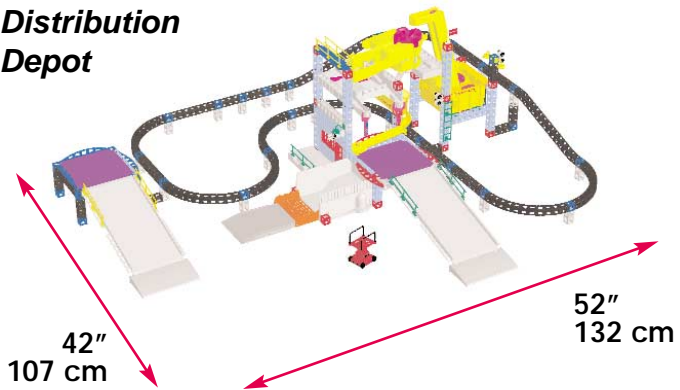

1

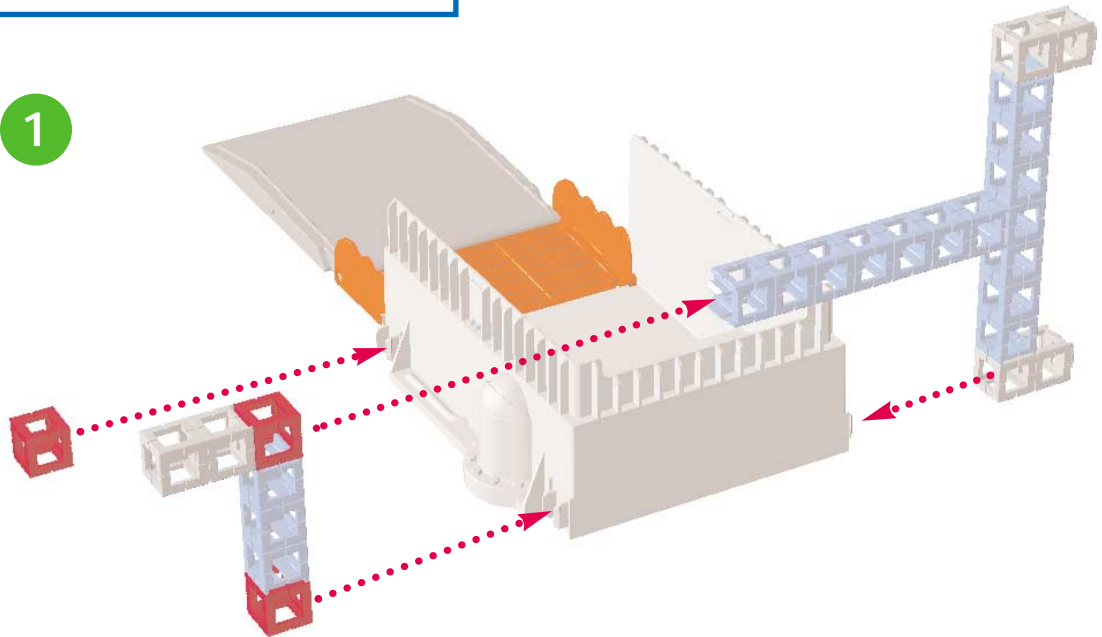

2

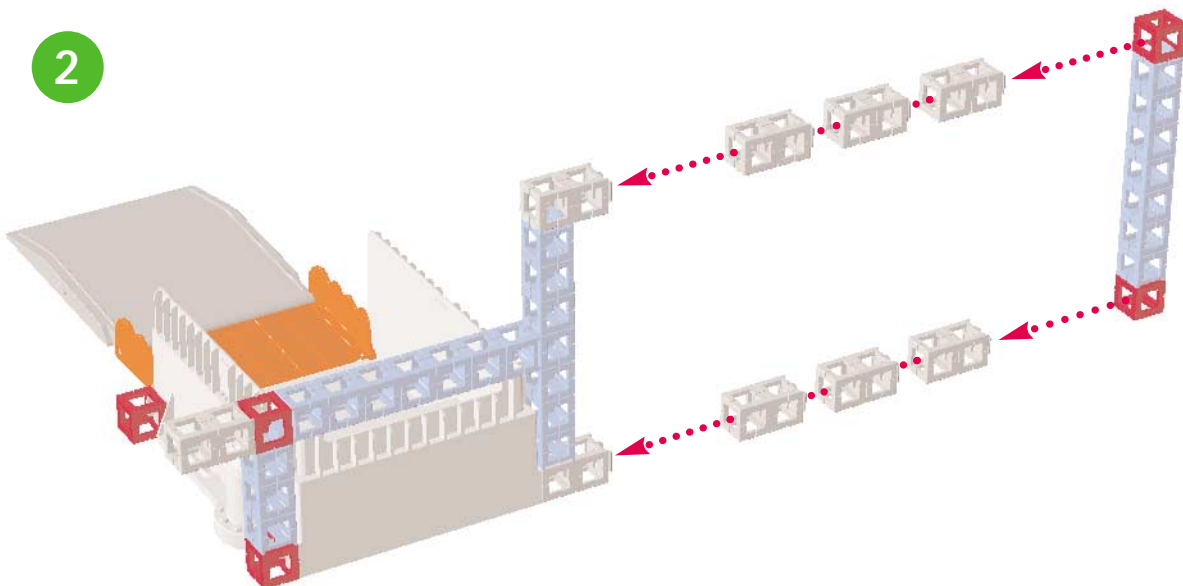

3

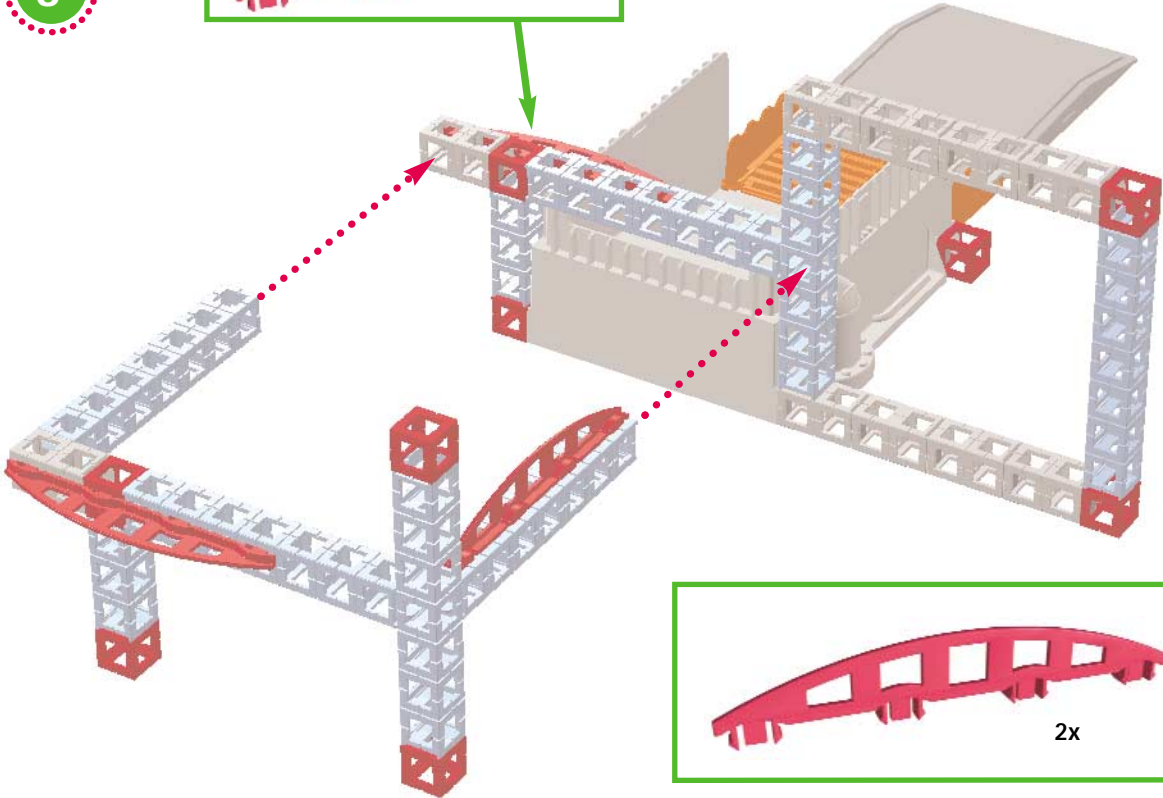

4

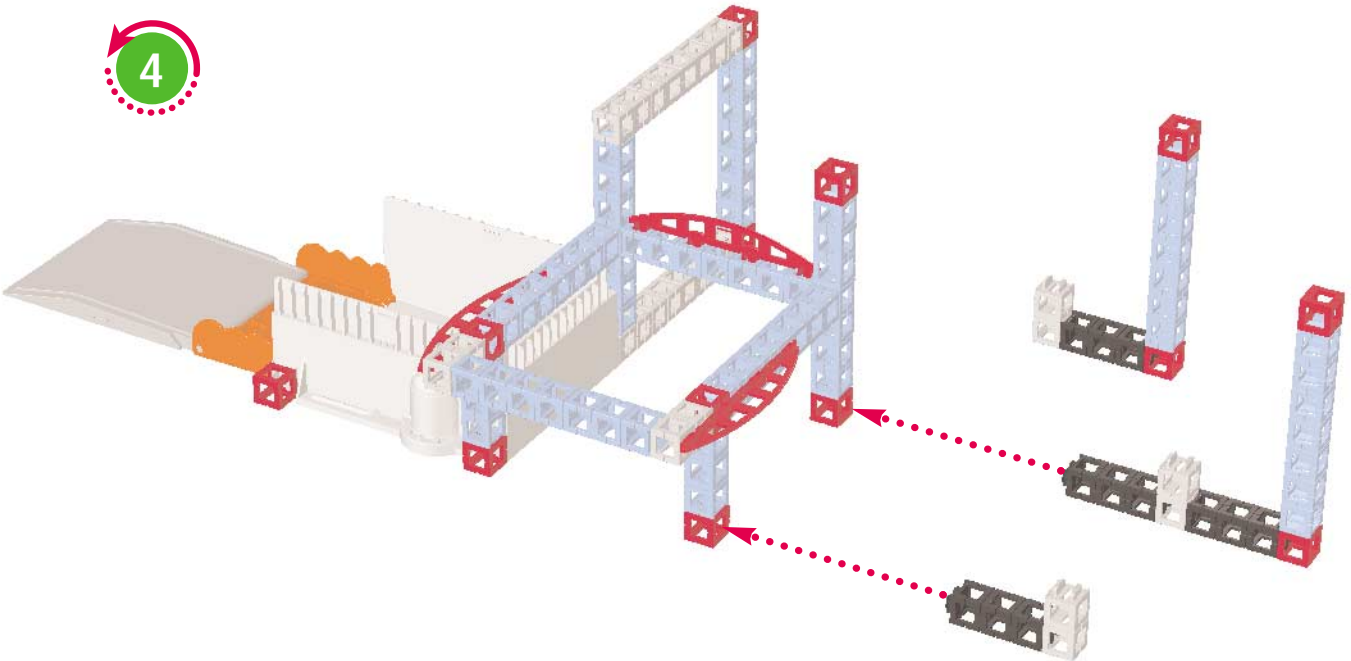

5

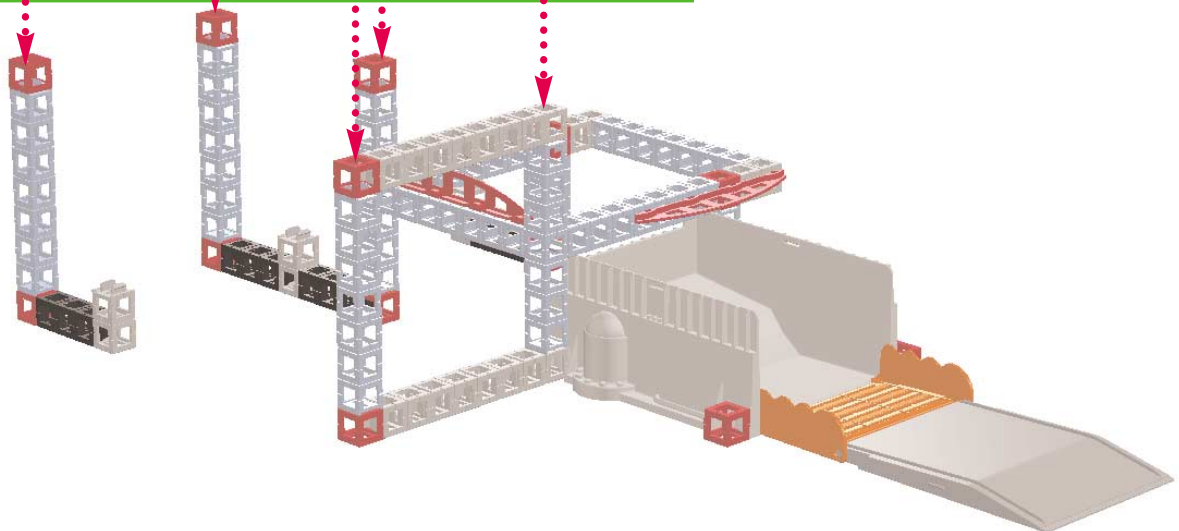
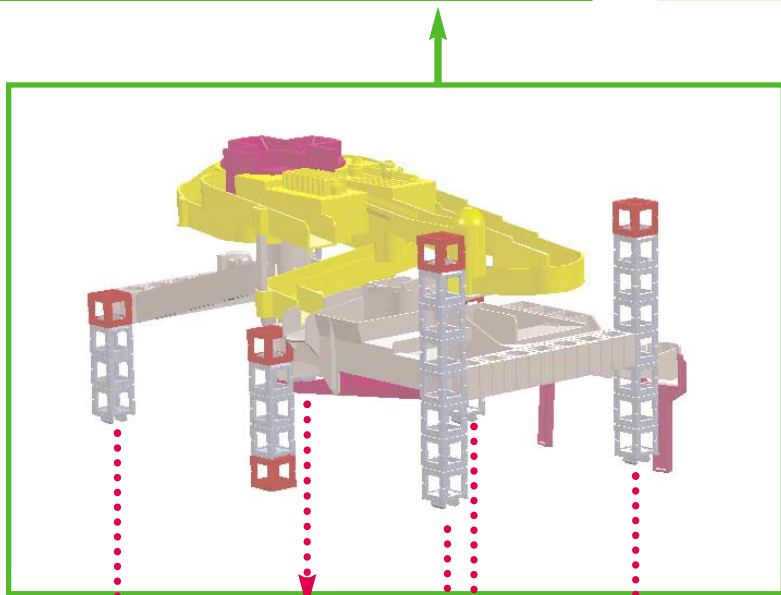
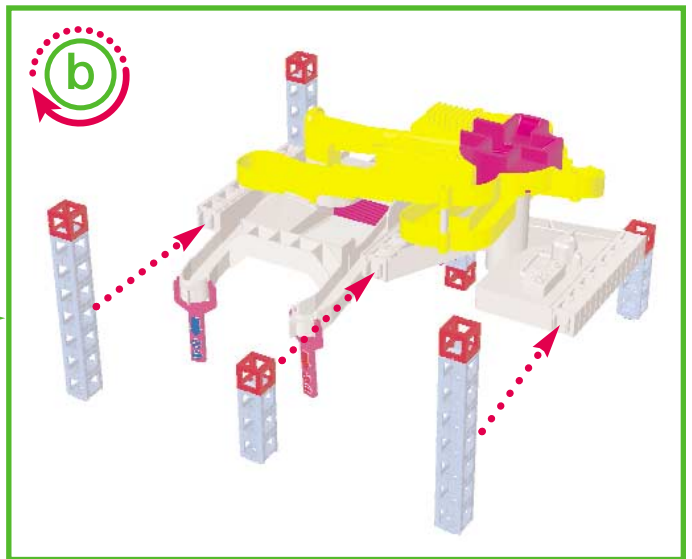
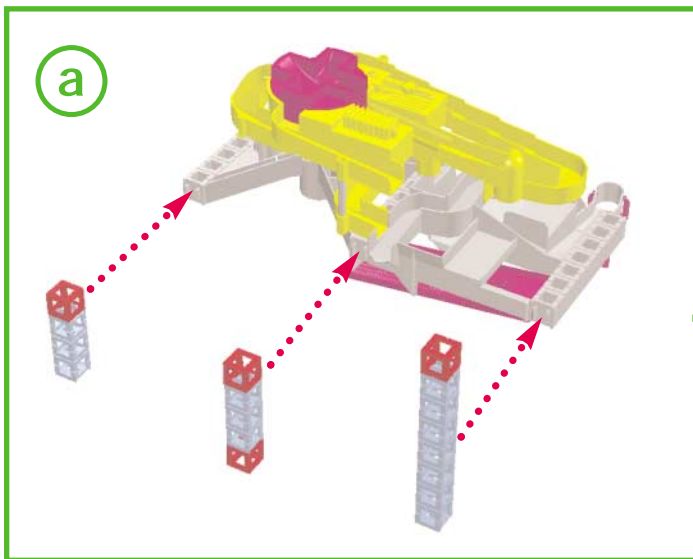



6

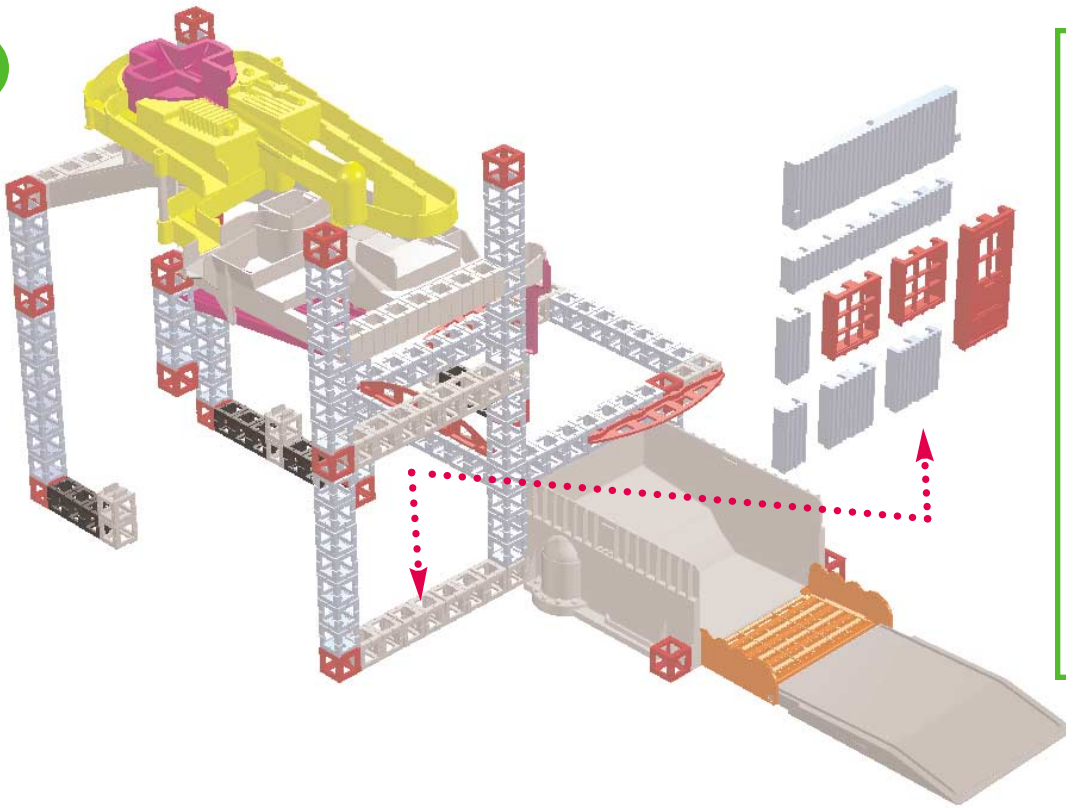

- 1x (Blue corrugated panel)
- 1x (Blue corrugated panel)
- 2x (Blue corrugated panel)
- 2x (Blue corrugated panel)
- 2x (Red window frame)
- 1x (Red door)

7

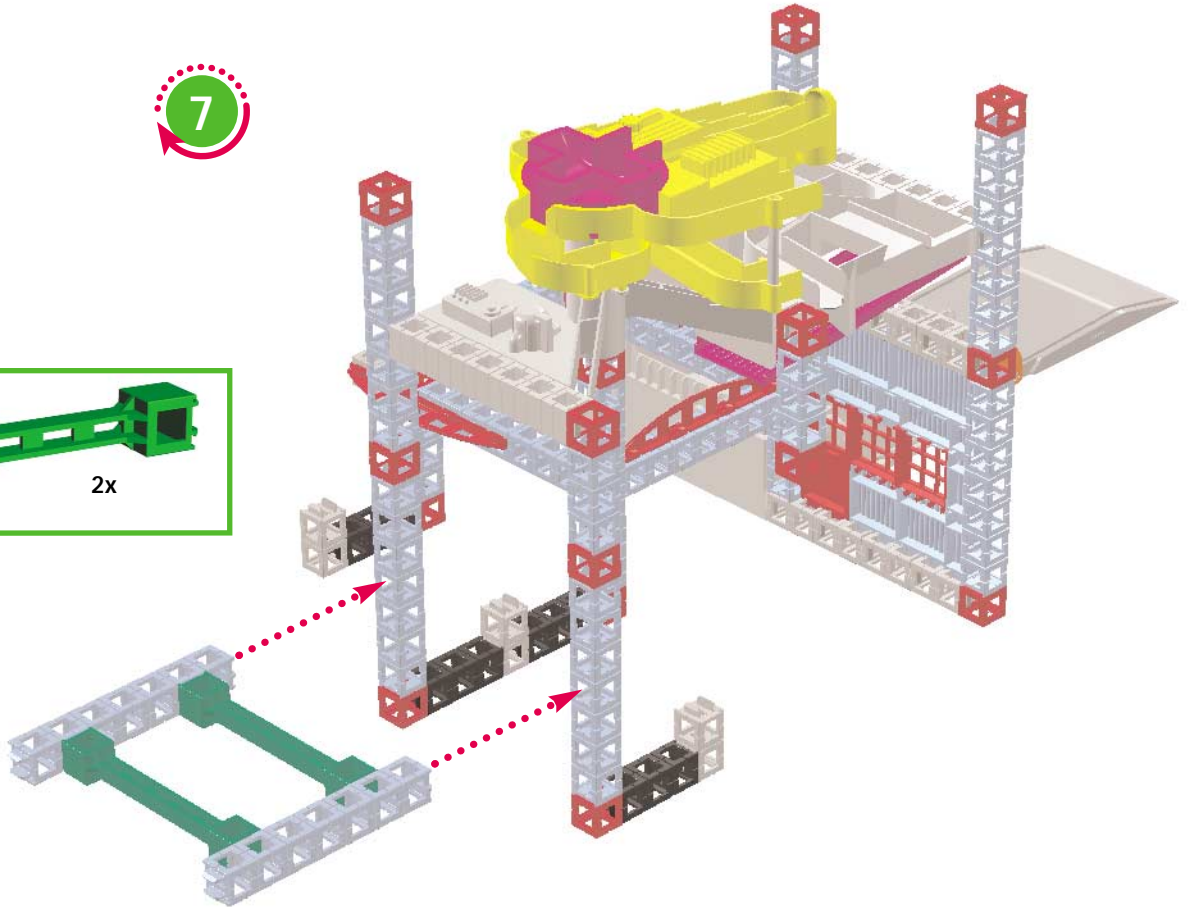
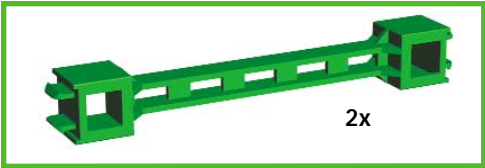

8

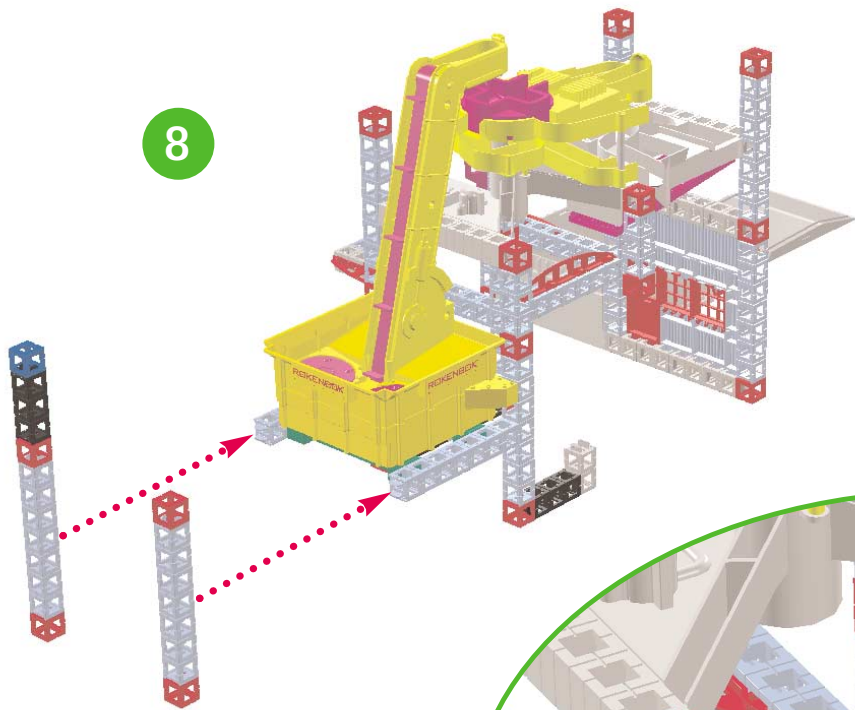

9

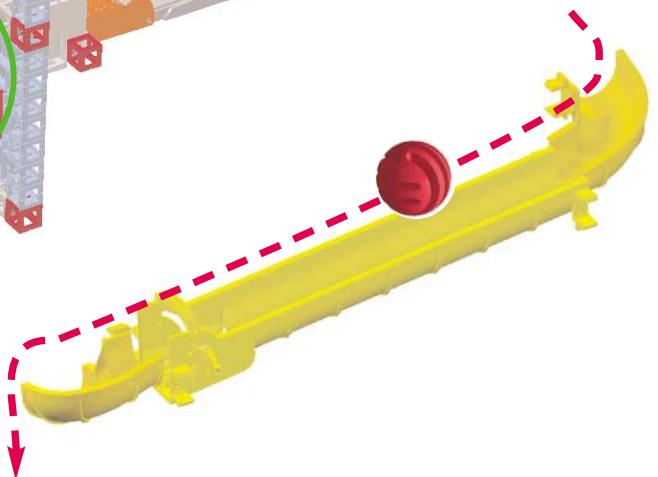
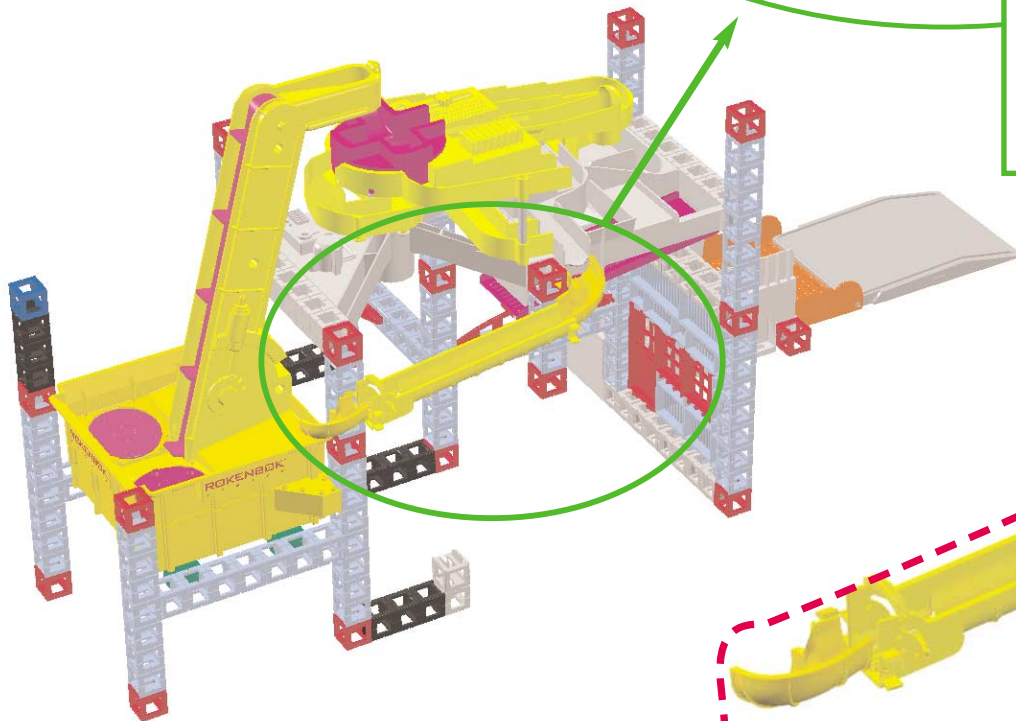
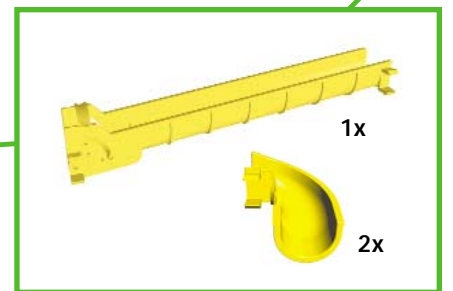
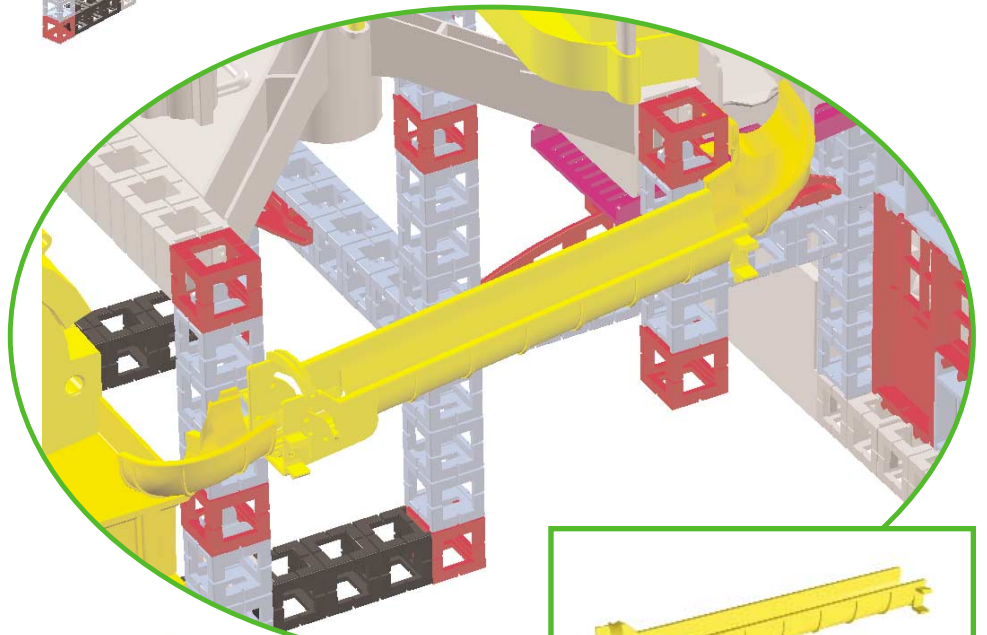



10

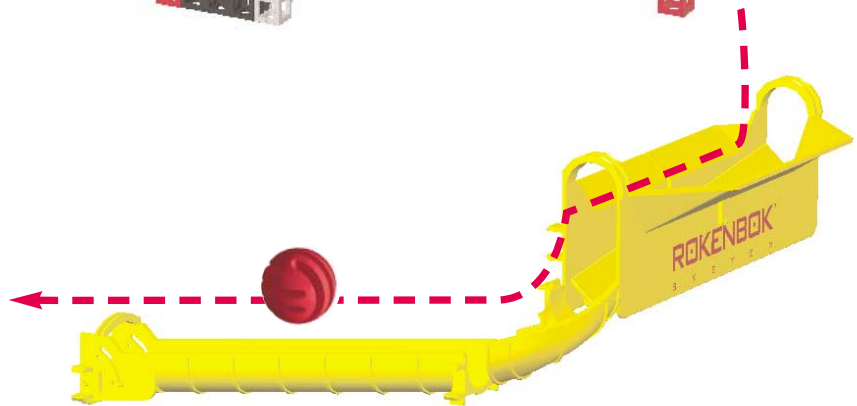
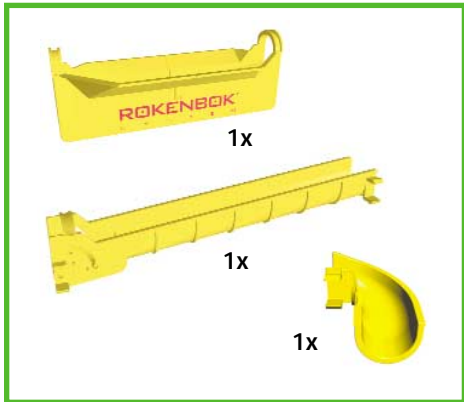
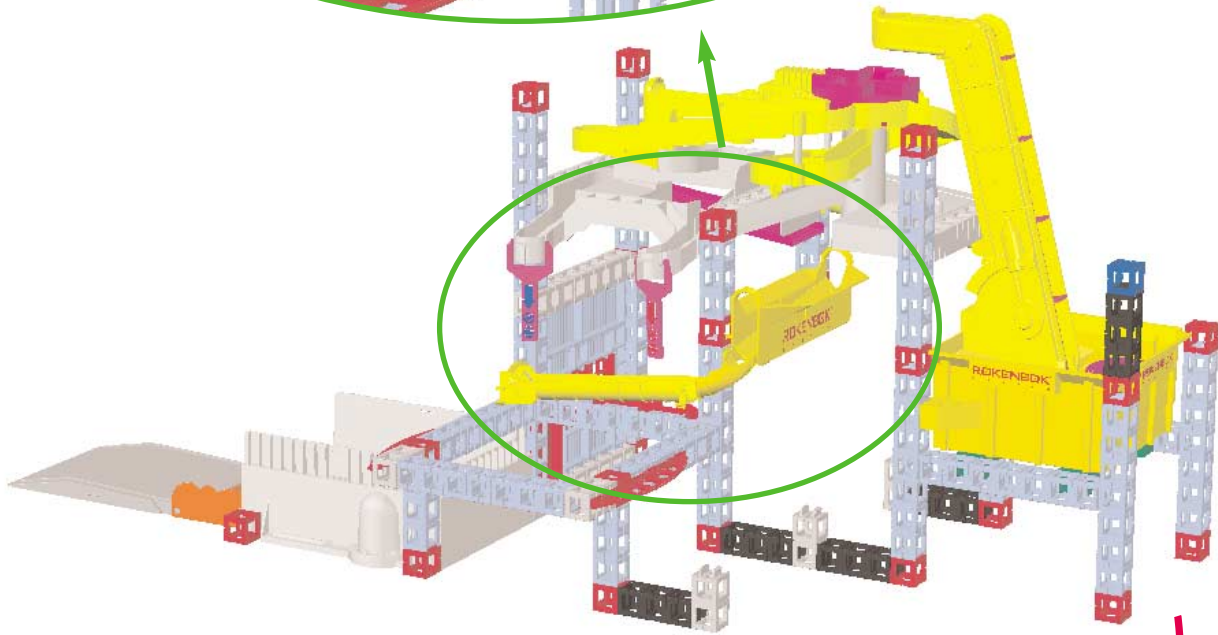
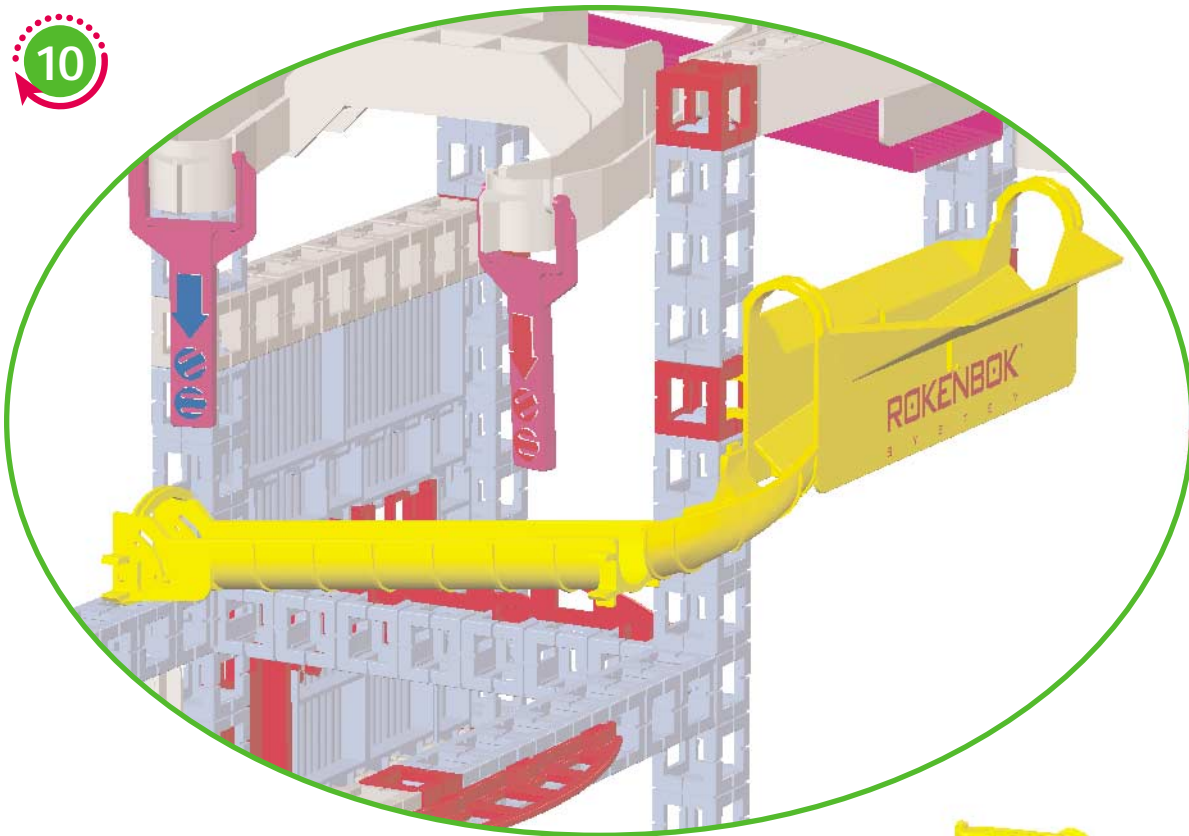

11

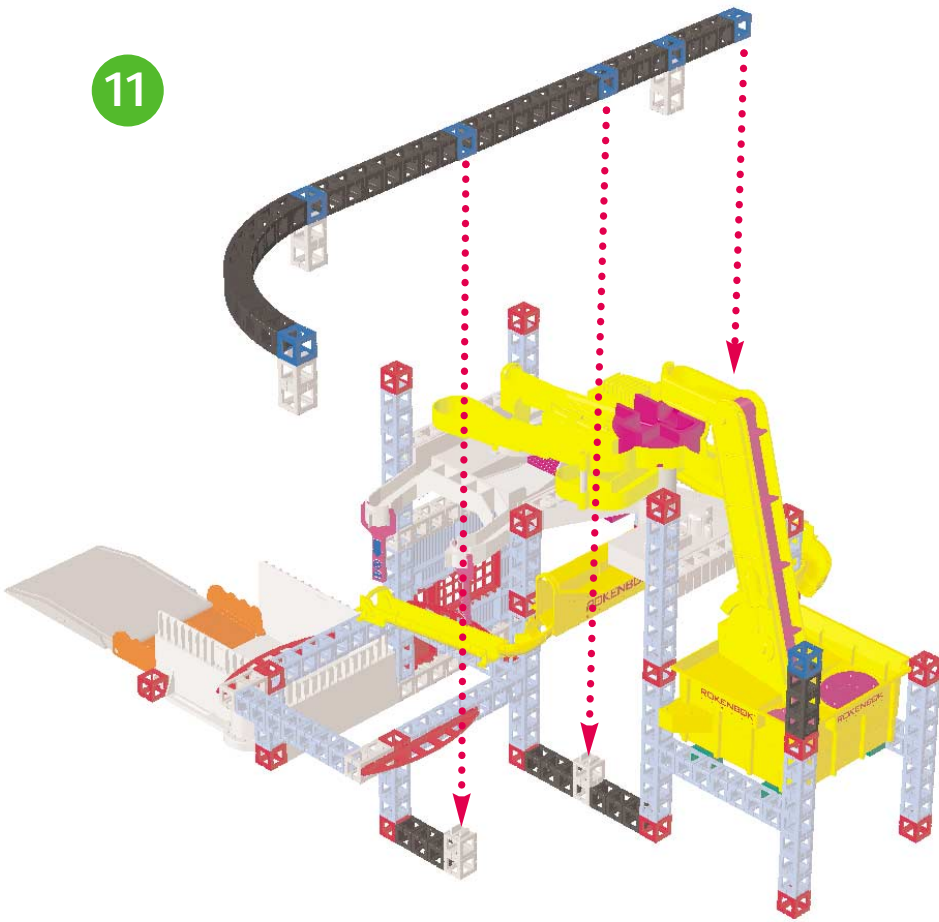

12

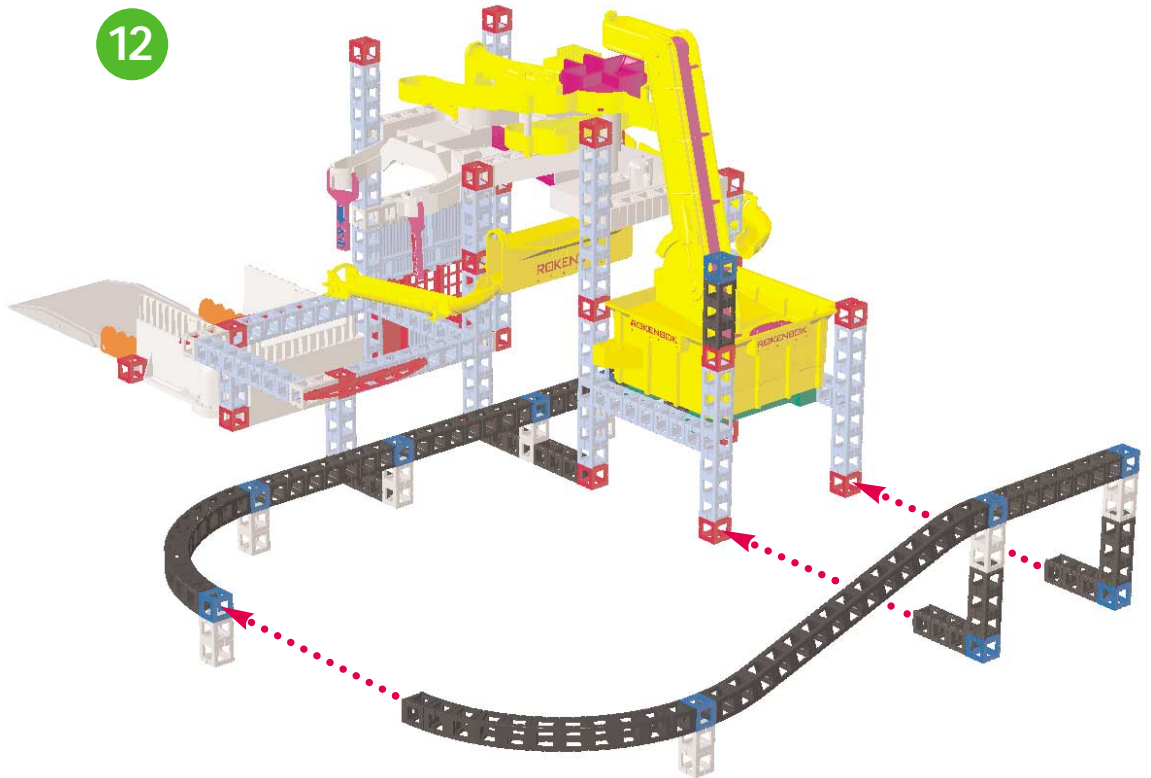



12

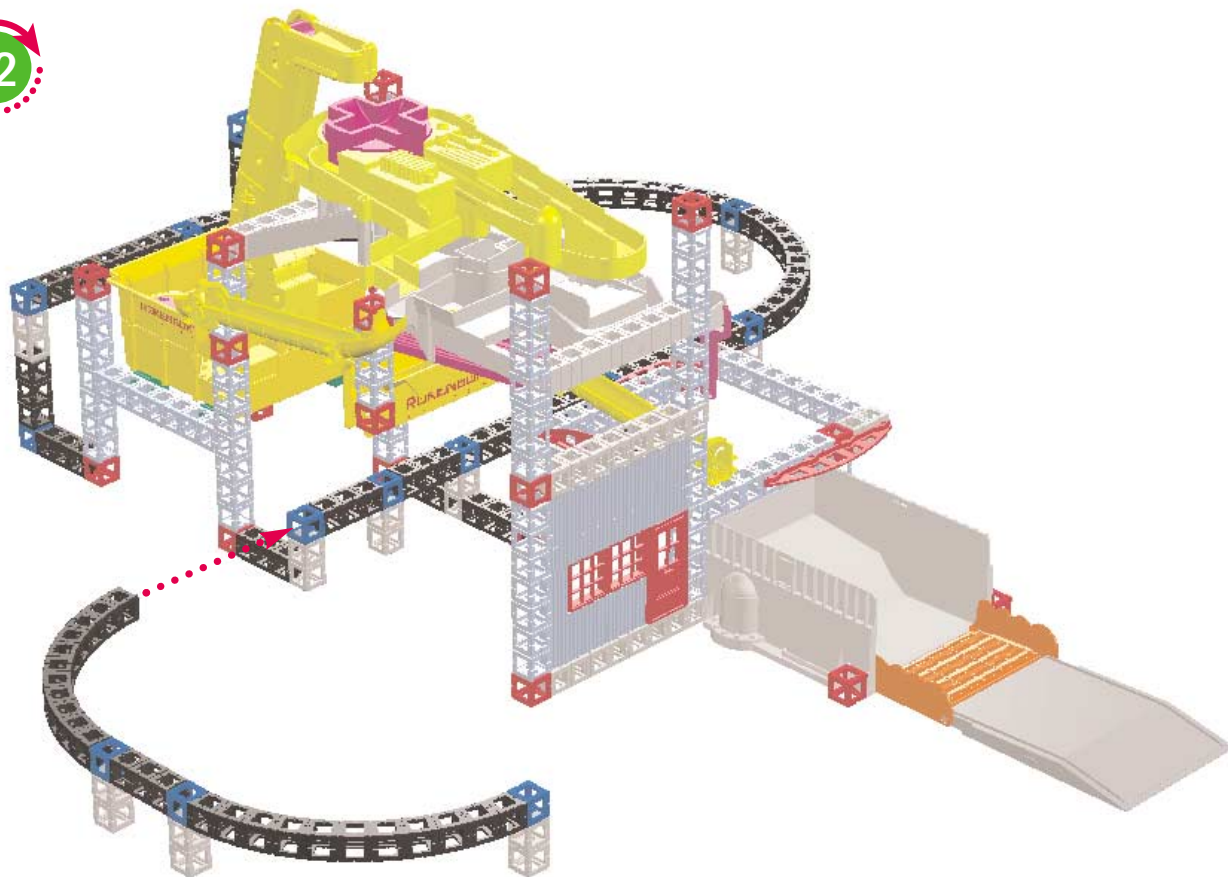

13

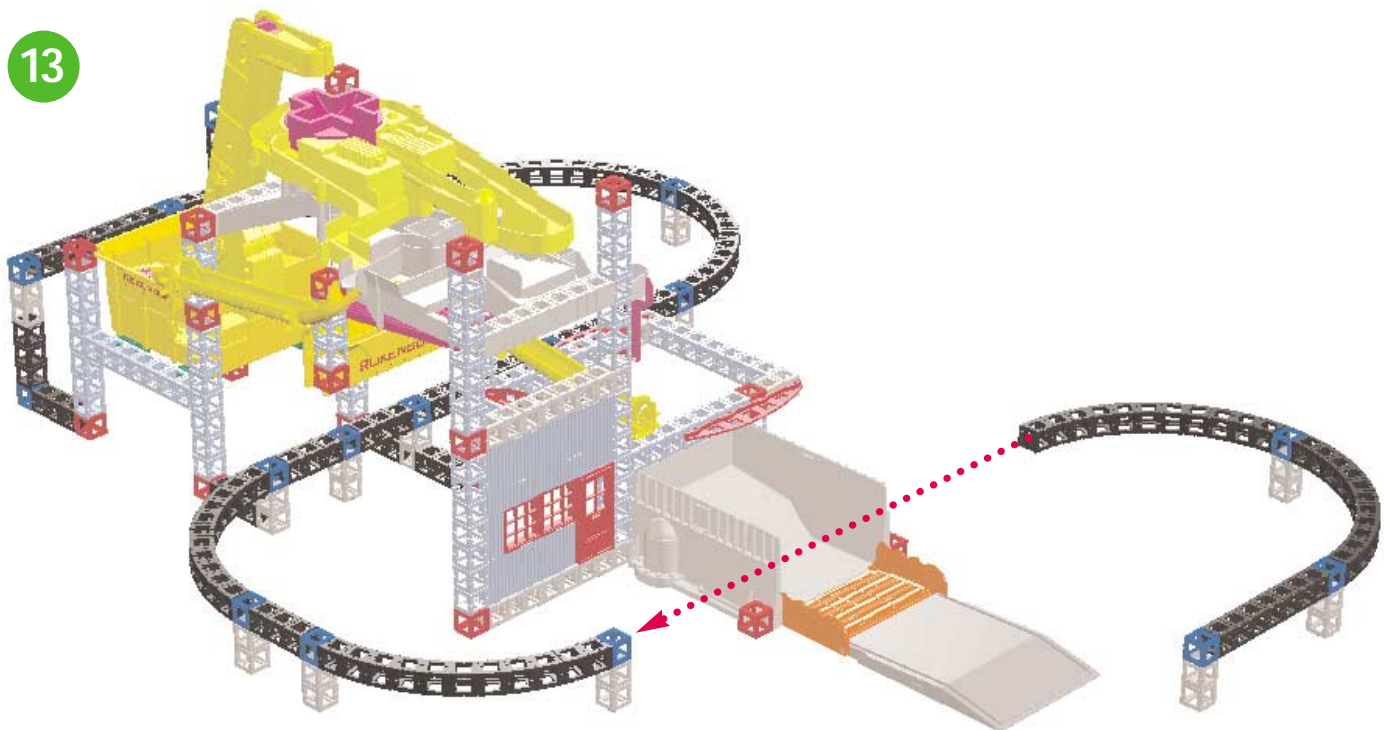



14

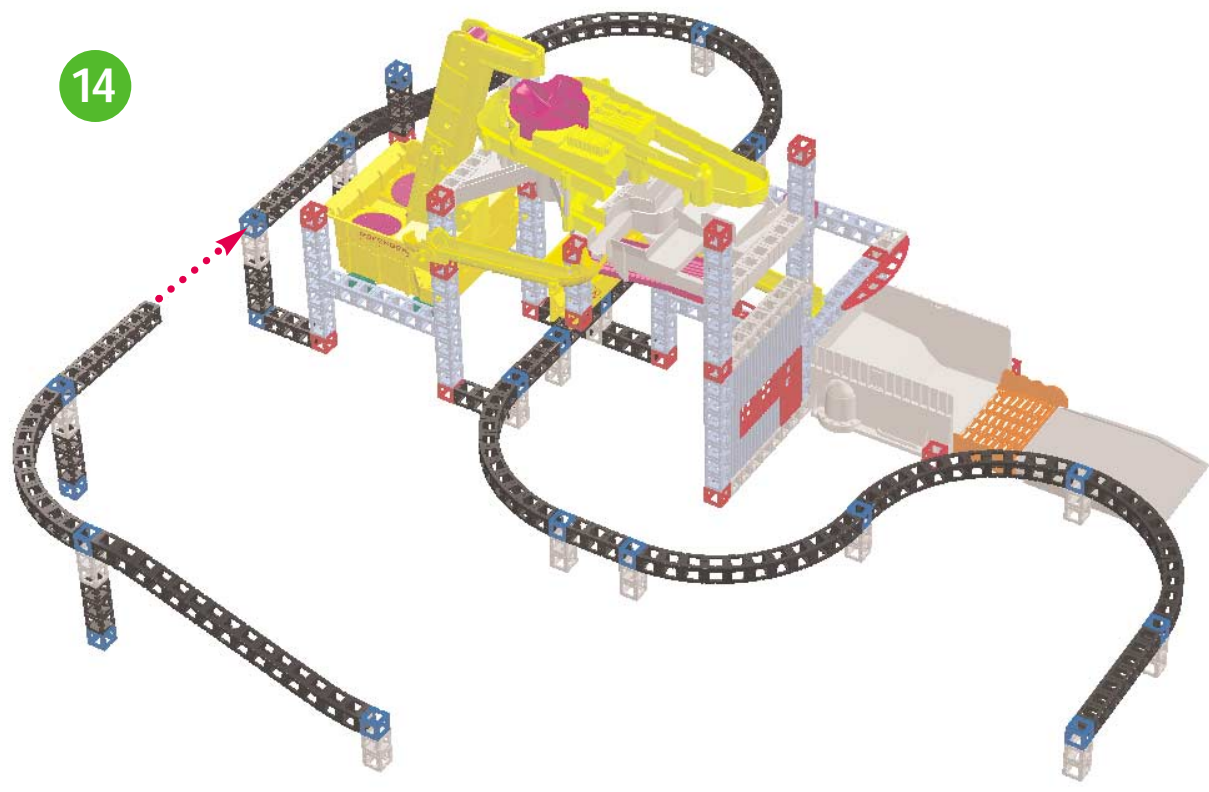

15

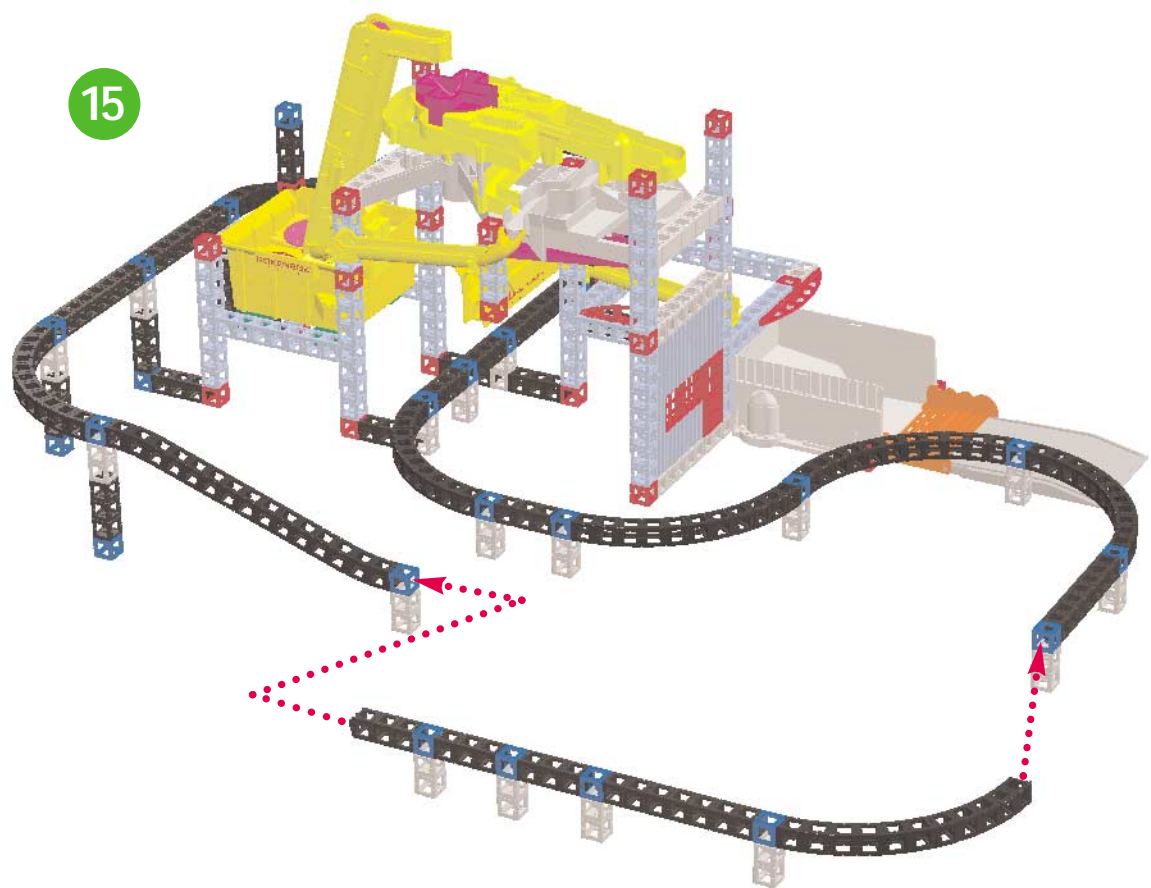

16

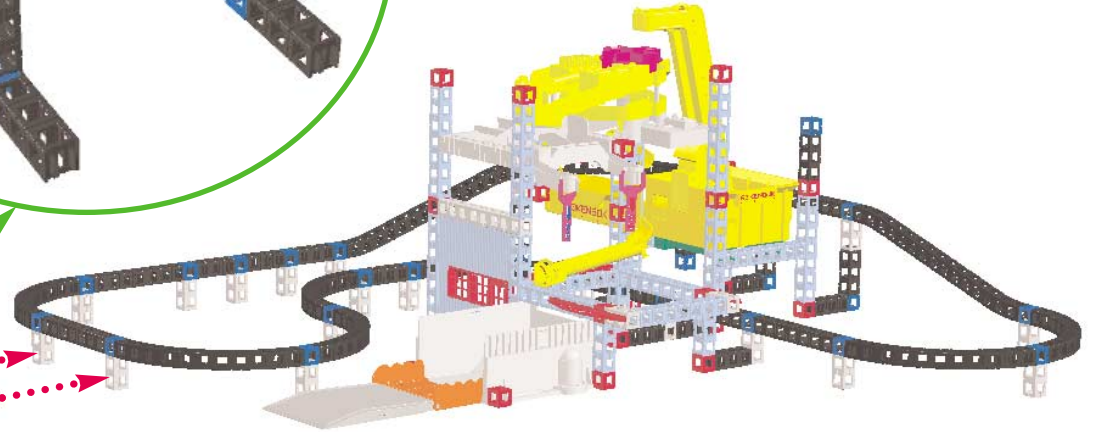
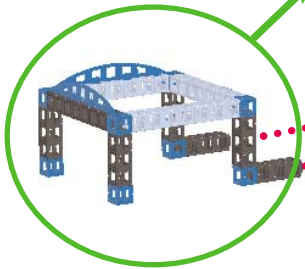
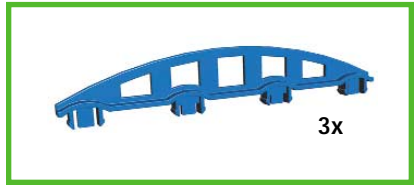
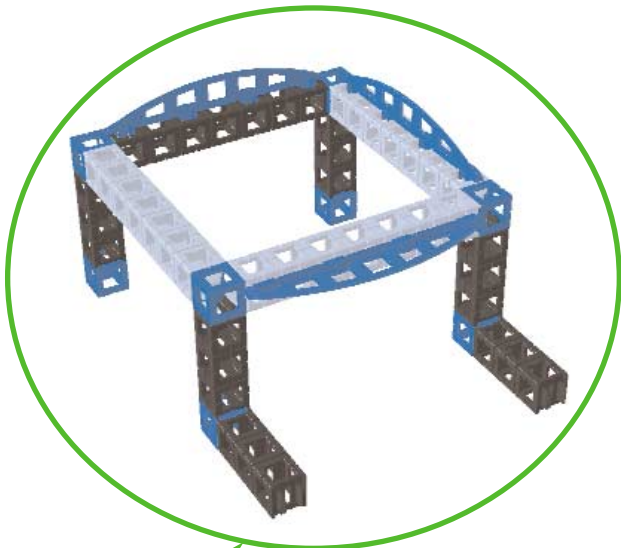

17

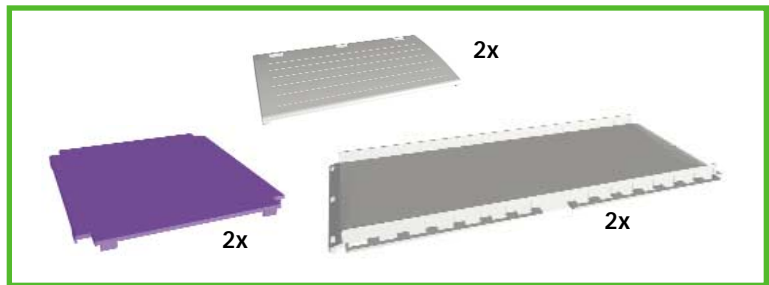
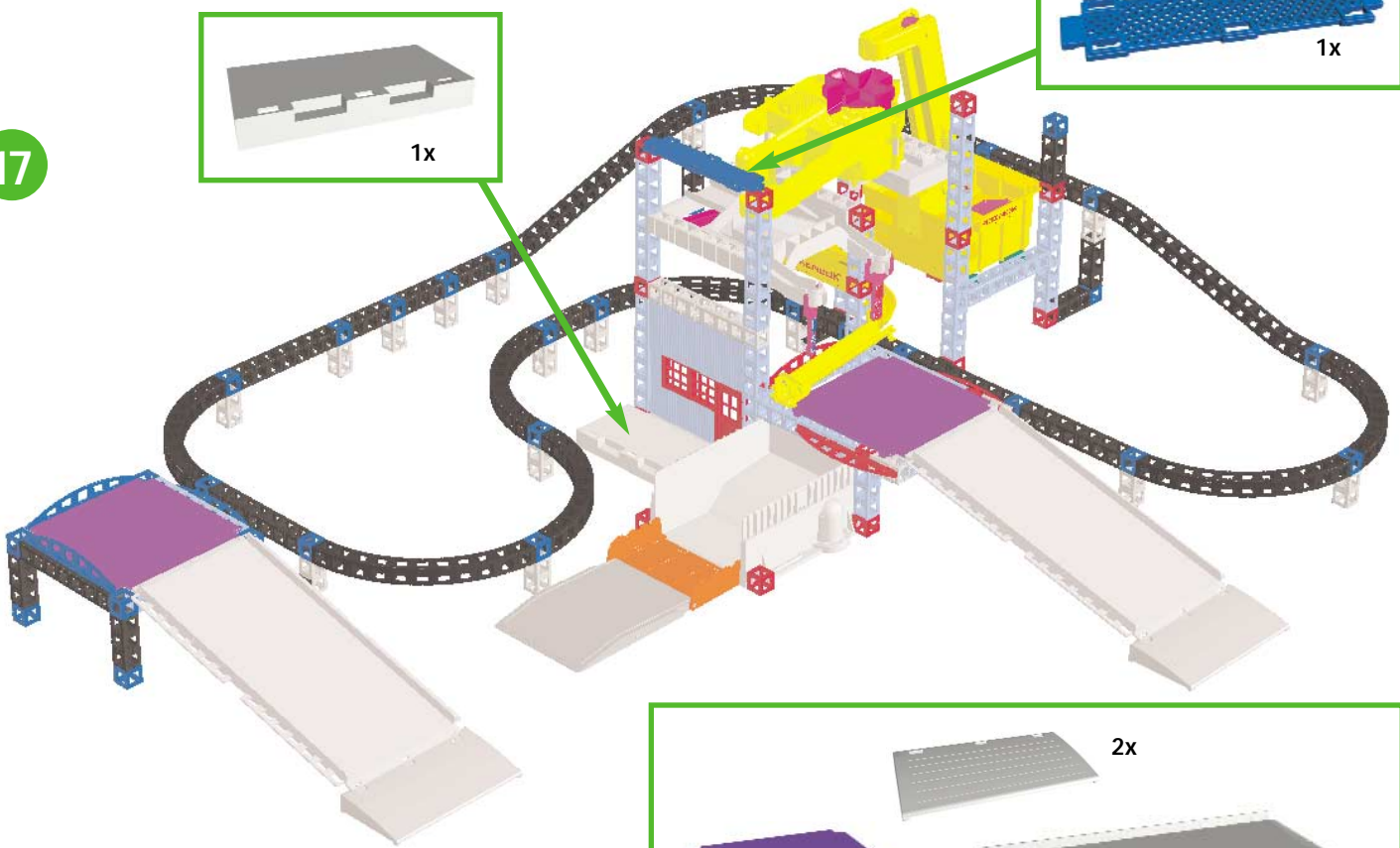
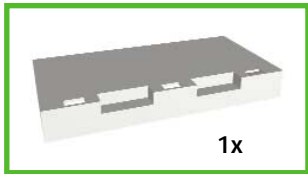



18

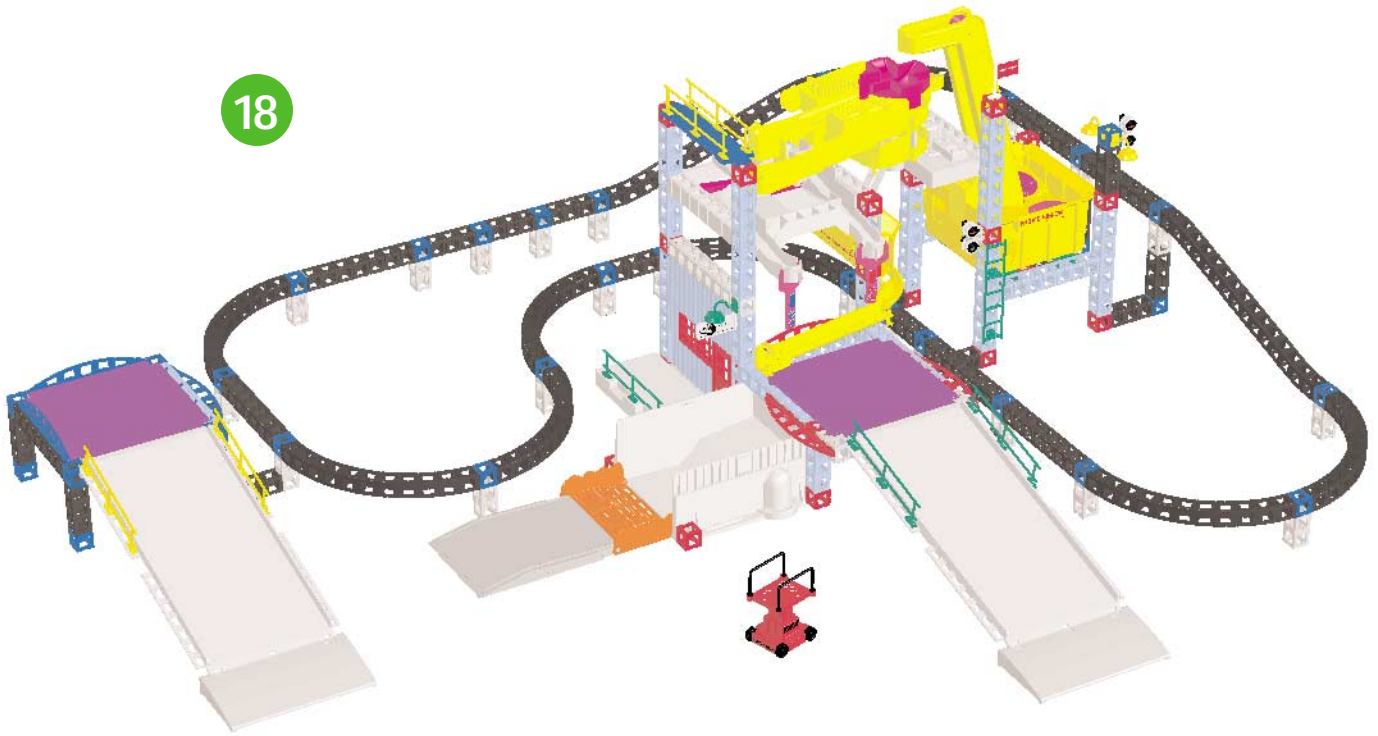

1x



1x



1x



4x



1x



1x



3x



1x



1x

1x



1x



2x

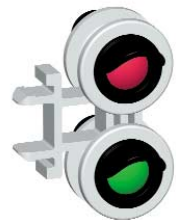

2x